



# STRATLOCK RAIL SYSTEM



The true and tested way  
to frame-up and efficiently  
mount panels.



Setting the standard for panel mounting

# Perfect framing.



## FAST AND TRUE FRAMING SYSTEM

The Stratlock Rail System offers a truly flexible extrusion system designed for efficient and accurate framework construction, with one extrusion for both vertical and horizontal framing onto walls and ceilings. The SL-RLE is a modern, modular aluminium profile for support of decorative panels in medium stress applications.



### SL-RLE

Aluminium extrusion for horizontal and vertical framing

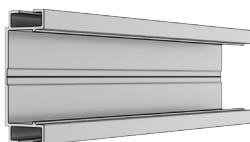

## FLEXIBLE CONNECTOR SYSTEM

Three connection options to suit a variety of structure types.

### SL-RCF90

Fixed 90° connector into SL-RLE for walls.



### SL-RCA180

For use with SL-RCF90 for wall to ceiling corner connector with 180° adjustability.



### SL-RCAB180

For use with SL-RCF90 for wall to wall corner connector with 180° adjustability.



# Perfect mounting.

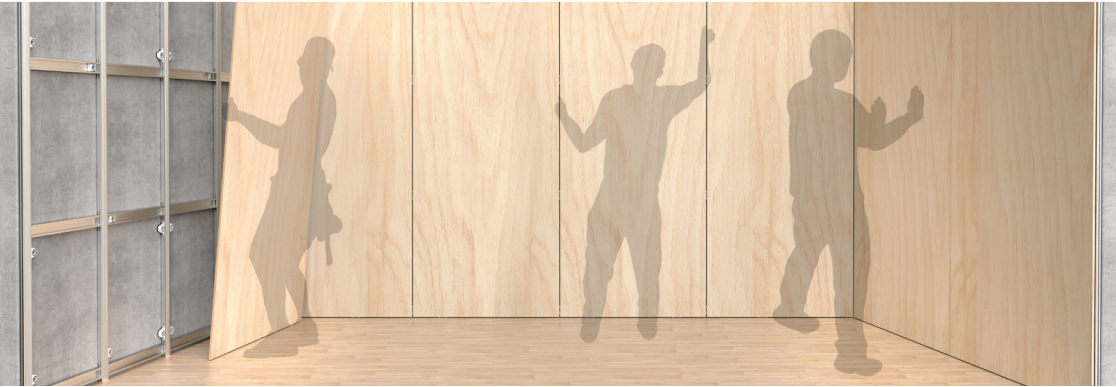

## PANEL MOUNTING WITH THE STRATLOCK RANGE



### APPLY PANELS

Align male clips with female clips, and press to first click.



### ADJUST SPACING

While the panel is supported at the first click, it can be adjusted 4mm in any direction.



### LOCK PANELS

Once the final position is located, firmly press the panel to lock into position.

## BENEFITS

- Low assembly costs
- One profile for all orientations streamlines the construction process
- Non-mechanical machining saves time
- Allows flexibility in grid design according to specific needs
- Simple assembly
- Compatible with Stratlock Range clips for accurate panel mounting

## APPLICATIONS

- Mounting large wall and ceiling panels
- Hotels, hospitals, civic buildings
- Contract interiors
- Prefabricated interiors

# Introducing the Fastmount® Stratlock® Rail System.

• SL-FA

• SL-RLE

• SL-RCF90

• SL-RLE

• SL-FB

• SL-M18

Wall framework solution:

**SL-RLE** - horizontal + vertical extrusion

**SL-RCF90** - perpendicular connector

**SL-FA** - vertical extrusion

**SL-FB** - horizontal extrusion

**SL-M18** - wall panel



# STRATLOCK RAIL SYSTEM

## Contents

Introduction to the Stratlock Rail System	1
Stratlock Rail Extrusion SL-R	6
Stratlock Connectors SL-RC	8
Stratlock Clip Range SL	10
Product Sheet - Stratlock Rail	12
Product Sheets - Stratlock Connectors	14
Installation Guide - Fitting connectors	18
Installation sheets - configuring framework	21
Product Sheets - Stratlock Clip Range	25
Installation Guide - Stratlock Clip Range	29
Clip Layout Guides	33
Panel Offset Guide	37
Technical Information	39
Frequently Asked Questions	40
Maintenance Guide	41
Fastmount Authorised Distributors	42
Fastmount Product Range	43

Reframe how you  
think about framework.

• SL-RLE

• SL-RCF90

• SL-RLE

Creating and decorating aluminium framework has never been faster or more flexible. With only one profile required and adaptable connectors, the Stratlock Rail System is a foolproof way to create a consistent substrate for the perfect panel finish.



Framing connected  
with SL-RCF90



Wall framework solution:

**SL-RLE** - horizontal + vertical extrusion  
**SL-RCF90** - perpendicular connector

# STRATLOCK RAIL EXTRUSION

# SL-R



The Stratlock Rail Extrusion is a unique framework system that allows an efficient method of framing up a wall grid to support decorative panels in low stress applications.

The Stratlock SL-RLE is a unique extrusion that can be used for both horizontal and vertical framing, removing the need for orientation-specific extrusions.



## SL-RLE STRATLOCK RAIL EXTRUSION

Available in 3m lengths, can be cut and assembled in grid format using appropriate Stratlock connectors. One profile for horizontal and vertical framing. Aluminium grade 6063 T5.

Weight per metre 405 grams.

Overall width 58mm, overall depth 22.3mm

See pages 12-16, 21-24 for more technical details.

## STRATLOCK® RAIL EXTRUSION TERMINOLOGY

Profile end - cut end of the extrusion

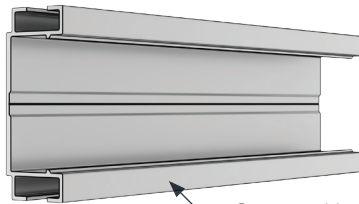

Channel - wide mouth on front face of profile

Groove - thin channel on side of profile

Easy assembly.



#### FIXED 90° CONNECTION FOR WALLS AND CEILINGS



#### WALL TO CEILING CONNECTIONS

Corner connector with 180° adjustability for perpendicular rails.



#### WALL-TO-WALL CORNER CONNECTIONS

Corner connector with 180° adjustability for parallel rails.





# STRATLOCK RAIL CONNECTORS

# SL-R



Stratlock Rail Connectors make wall and ceiling grid assembly efficient and foolproof.

The Stratlock Rail Connector Range offers connectors that enable a variety of functions, including creating a wall, creating a wall to wall corner, or creating a wall to ceiling corner with 180 degree adjustability.



## **SL-RCF90** WALL CONNECTOR

Creates a 90 degree fixed joint between the SL-RLE groove and profile end when building a wall, combines with SL-RCA180 for wall to ceiling connection or SL-RCAB180 for wall to wall corner connection. Diecast aluminium alloy ADC12. Installs with provided small hex head grub screw (stainless steel).

See pages 14-22 for more technical details.



## **SL-RCA180** WALL TO CEILING CONNECTOR

Pairs with SL-RCF90 to create wall to ceiling connection with 180° adjustability. Fits into SL-RLE profile end with supplied SS grub screws, and connects with SL-RCF90 with supplied socket screws. Die cast aluminium alloy ADC12.

See pages 15, 19, 22 for more technical details.



## **SL-RCAB180** WALL TO WALL CONNECTOR

Pairs with SL-RCF90 to create a wall to wall corner connection with 180° adjustability. Fits into SL-RLE profile groove with supplied SS grub screws, and connects with SL-RCF90 with supplied socket screws. Die cast aluminium alloy ADC12.

See pages 16, 20, 22-24 for more technical details.



## **SEE OUR INSTALLERS GUIDE**

From how to create a wall, to a corner, to a ceiling connection, our installation guides take you through how to construct a wall and attach decorative panels in detail.



# Accurate mounting.

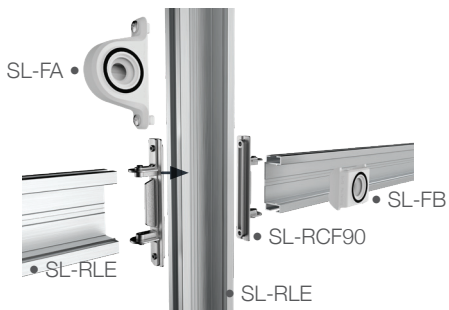

## Finish the job perfectly.

Use the Fastmount Stratlock Range to mount large and heavy decorative panels to the Stratlock Rail System. With a patented place-position-lock functionality, this is panel mounting - made perfect.

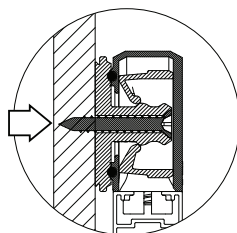
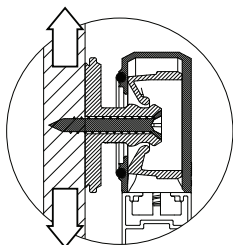
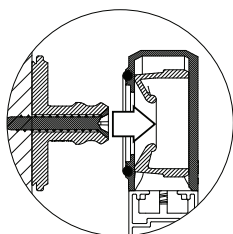

# STRATLOCK

## SL RANGE

# SL



The Stratlock Range is a heavy-duty panel mounting solution for mounting heavy interior panels onto aluminium or steel extrusion framework, designed specifically for the contract interior fit out industry. With no special installation tools required, the Stratlock Range is a hidden fixing that installs rapidly into the framework and panel, provides supported adjustment of the panel before locking into place, and boasts our highest shear strength and pull out load of 18kg. Typical applications include heavy wall and ceiling panels in the interiors of hotels, hospitals, retail and residential. Patent Pending.

---

### **SL-FA/SL-FA-FR** STRATLOCK FEMALE SIDE MOUNT

Female side mount clip with twist lock installation into aluminium extrusion. Fits into groove of vertical or horizontal SL-RLE. New solid-style internal load chassis. 10kg pull out load with SL-M10, 18kg with SL-M18. No special tools required for installation.

See pages 25, 29, 30 for more technical details.

---

### **SL-FB/SL-FB-FR** STRATLOCK FEMALE FRONT MOUNT

Female front mount channel insert with push fit installation. Fits into channel of horizontal SL-RLE profiles or 18mm standard galvanized steel rail framework with channel dimensions of mouth: 35.0mm - 35.75mm, depth: min 15.75mm - 16.5mm. New solid-style internal load chassis. 10kg pull out load with SL-M10, 18kg with SL-M18. No special tools or screws required for installation.

See pages 26, 31 for more technical details.

---

### **SL-M18/SL-M18-FR** STRATLOCK MALE 18KG

Male clip with two-stage engagement for adjustable panel positioning and locking. Fixes to panel with #8 screw, or surface mount with SuperGroove Adhesive. Mounts into SL-FA, SL-SFA, SL-FB and SL-FC. 18kg pull out load. No special tools required for installation.

See pages 28-31 for more technical details.

---

### **SL-M10** STRATLOCK MALE 10KG

**! NEW**

Male clip with two-stage engagement for adjustable panel positioning and locking. Fixes to panel with either 1 x #8 screw or 3 x #8 screws; or adhesive fix with Fastmount SuperGroove® Adhesive. Mounts into SL-FA, SL-SFA, SL-FB and SL-FC. 10kg pull out load. No special tools required for installation.

See pages 27, 29-31 for more technical details.

 **TOOLS**



NOTE: Clips shown above are those compatible with the Stratlock Rail System. Please refer to Fastmount Product Catalogue to view entire Stratlock Range.

Corners  
made easy.

• SL-RCF90

• SL-RCAB180





# STRATLOCK RAIL SYSTEM

# SL-R

## PRODUCT SHEET

### SL-RLE Stratlock® Rail - Large Extrusion

#### SPECIFICATIONS:

The Stratlock SL-RLE is a unique extrusion that can be used for both horizontal and vertical framing, removing the need for orientation-specific profiles. Install with the Stratlock Rail Connector Range to create a wall, corner, or ceiling connection with fixed or 180° adjustability. Fixes to existing substrate using appropriate fasteners. Ideal for the support of decorative panels in medium stress applications.

Available in 3 metre lengths, the SL-RLE can be cut and assembled in grid format using appropriate Stratlock connectors. One profile for both horizontal and vertical framing on walls and ceilings. Aluminium grade 6063 T5.



USE WITH:  
SL-RCF90

SL-RCA180

SL-RCAB180



#### MATERIAL:

Aluminium grade 6063 T5

#### MORE INFO:

Installation Guide SL-RCF90,  
SL-RCA180, SL-RCAB180

#### BENEFITS

- One extrusion for vertical and horizontal planes
- Reduction of installation time
- Lightweight aluminium
- Simple assembly - order & cut according to wall design
- Compatible with Stratlock Range clips for mounting large and heavyweight panels
- No special tools required for assembly
- CAD files available for easy specification

#### APPLICATIONS

- Walls and ceilings
- Commercial interior fit out
- Hotels, hospitals, retail, residential
- Fire-rated interiors
- Exhibitions
- Offices

**INSTALLATION:** Partially exploded through section showing typical installation method

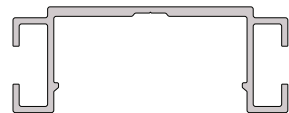
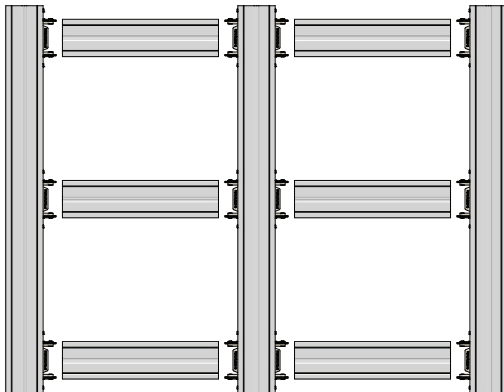

Overall profile width 58mm  
Overall profile depth 22.3mm



# Connectors for every application.

Connecting aluminium extrusions to build wall and ceiling grids has never been easier. Choose from three connection options that enable fixed or flexible connections depending on your layout.



180 degree adjustability for maximum installation flexibility



Wall connection:  
**SL-RCF90**

Wall to ceiling connection:  
**SL-RCA180**

Wall to wall connection:  
**SL-RCAB180**

## SL-R

## PRODUCT SHEET

**SL-RCF90** Fixed wall connector**SPECIFICATIONS:**

The SL-RCF90 is the foundation for all three connections available in the Stratlock Rail System. It provides installers with three connection options: a 90° fixed joint between the SL-RLE groove and profile end when building a wall, combines with SL-RCA180 for a wall to ceiling connection or SL-RCAB180 for wall to wall corner connection. Made of diecast aluminium alloy ADC12. Installs with provided small hex head grub screw (stainless steel).

**SL-RCF90****USE WITH:**

SL-RLE

SL-RCA180

SL-RCAB180

**MATERIAL:**

Diecast aluminium alloy ADC12

**MORE INFO:**Installation Guide SL-RCF90,  
SL-RCA180, SL-RCAB180**STRATLOCK RAIL SYSTEM****BENEFITS**

- No additional machining required
- Direct fixing into profile groove or end
- Stability nogs
- Minimal construction effort
- Screws into position with provided grub screws
- Instant 90° connection
- No special tools required for installation
- Diecast aluminium alloy ADC12
- Simple assembly, reversible installation
- Enables pre-assembly

**APPLICATIONS**

- Construction of straight framework against existing wall
- Blind walls
- Contract interior fit out
- Hotels, hospitals, retail, residential
- Exhibitions
- Fire-rated wall panels

**INSTALLATION:** Partially exploded through section showing typical installation method

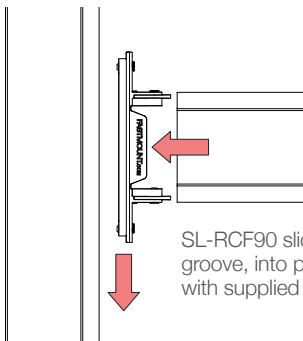
**FIXED 90° CONNECTION FOR WALLS AND CEILINGS**

SL-RCF90 slides into profile groove, into profile end, fastens with supplied grub screws.



# STRATLOCK RAIL SYSTEM

## SL-RCA180 Adjustable wall to ceiling connector

### SPECIFICATIONS:

The SL-RCA180 is a 180° adjustable connector that pairs with the SL-RCF90 to create a wall to ceiling, perpendicular connection. Made of diecast aluminium alloy ADC12. Fits into SL-RLE profile end. Installs with provided small hex head grub screw (stainless steel), and installs into SL-RCF90 with supplied socket screws.

#### SL-RCA180



#### USE WITH:

SL-RLE SL-RCF90

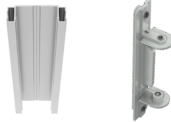

#### MATERIAL:

Diecast aluminium alloy ADC12

#### MORE INFO:

Installation Guide SL-RCA180



## STRATLOCK RAIL SYSTEM

### BENEFITS

- Enables simple construction of wall to ceiling corner with only 2 parts
- No additional machining required
- Direct fixing into profile groove & end
- Stability nogs
- Minimal construction effort
- Screws into position with provided grub screw
- 180° adjustability
- No special tools required for installation
- Diecast aluminium alloy ADC12
- Simple assembly, reversible installation
- Enables pre-assembly

### APPLICATIONS

- Modular construction
- Blind walls & ceilings
- Contract interior fit out
- Hotels, hospitals, retail, residential
- Exhibitions

**INSTALLATION:** Partially exploded through section showing typical installation method

### WALL TO CEILING CONNECTIONS

Corner connector with 180° adjustability for perpendicular rails.

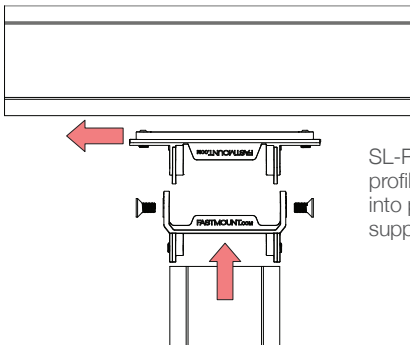

SL-RCA180 slides into profile groove, SL-RCF90 into profile end, fastens with supplied grub screws.





## SL-R

## PRODUCT SHEET

**SL-RCAB180** Adjustable wall to wall connector**SPECIFICATIONS:**

The SL-RCAB180 is a 180° adjustable connector that pairs with the SL-RCF90 to create a wall to wall, parallel profile corner connection. Enables the simple construction of wall corners to streamline the installation process. Made of diecast aluminium alloy ADC12. Installs into SL-RLE groove with provided small hex head grub screw (stainless steel), and installs into SL-RCF90 with supplied socket screws.

**SL-RCAB180****USE WITH:**

SL-RLE

SL-RCF90

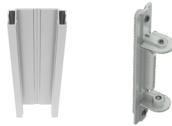
**MATERIAL:**

Diecast aluminium alloy ADC12

**MORE INFO:**

Installation Guide SL-RCAB180

**STRATLOCK RAIL SYSTEM****BENEFITS**

- Enables simple construction of wall to wall corner with only 2 parts
- No additional machining required
- Direct fixing into profile groove & end
- Stability nogs
- Minimal construction effort
- Screws into position with provided grub screw
- 180° adjustability
- No special tools required for installation
- Diecast aluminium alloy ADC12
- Simple assembly, reversible installation
- Enables pre-assembly

**APPLICATIONS**

- Corner construction
- Modular construction
- Blind walls & ceilings
- Contract interior fit out
- Hotels, hospitals, retail, residential
- Exhibitions

**INSTALLATION:** Partially exploded through section showing typical installation method

**WALL-TO-WALL CORNER CONNECTIONS**

Corner connector with 180° adjustability for parallel rails.

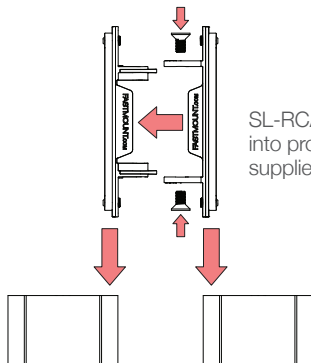

SL-RCAB180 and SL-RCF90 slide into profile groove and fastens with supplied grub screws.



• SL-RCF90

• SL-RLE

SL-RCF90 - Vert. + Horizontal



Wall framework solution:

**SL-RLE** - Vertical + horizontal profiles

**SL-RCF90** - fixed 90° connector

# SL-R

## INSTALLATION GUIDE

### SL-RCF90 How to fit connector - building a wall

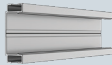
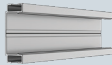
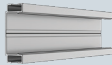
<p><b>SL-RCF90</b></p> 	<p><b>USE WITH:</b></p> <table border="1"> <tr> <td data-bbox="604 430 716 526"> <p>SL-RLE</p>  </td> <td data-bbox="750 430 918 494"> <p>Grub screws (supplied) 2.5mm hex key</p> </td> </tr> </table>	<p>SL-RLE</p> 	<p>Grub screws (supplied) 2.5mm hex key</p>
<p>SL-RLE</p> 	<p>Grub screws (supplied) 2.5mm hex key</p>		

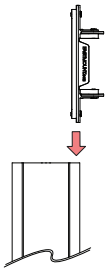
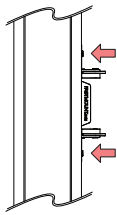
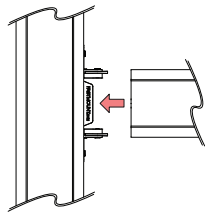
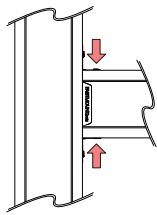
<p>Slide SL-RCF90 into groove of SL-RLE</p> 	<p>Tighten grub screws with 2.5mm hex key or right angle drive for battery drill</p> 	<p>Insert horizontal SL-RLE profile end into SL-RCF90</p> 
<p>Tighten grub screws with 2.5mm hex key</p> 		

# STRATLOCK RAIL SYSTEM

## SL-RCA180 How to fit connector - building a wall to ceiling connection

SL-RCA180



USE WITH:

- SL-RCF90
- Grub screws (supplied)
- Socket screws (supplied)
- 2.5mm hex key
- 3mm hex key



Remove grub screws from teeth of SL-RCF90



Slide SL-RCF90 into groove of horizontal SL-RLE

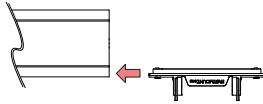

Tighten grub screws with 2.5mm hex key once in position

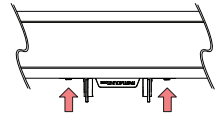

Insert SL-RCA180 into profile end of vertical SL-RLE

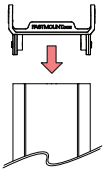

Tighten grub screws with 2.5mm hex key

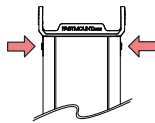

Insert SL-RCF90 into SL-RCA180

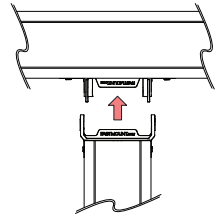

Insert socket screws and fasten enough to hold connectors together

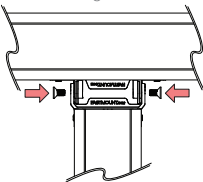

Adjust horizontal rail to desired angle, tighten socket screws with 3mm hex key

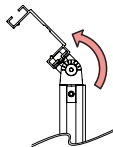



# SL-R

## INSTALLATION GUIDE

### SL-RCAB180 How to fit connector - building a wall to wall connection

<p><b>SL-RCAB180</b></p> 	<p><b>USE WITH:</b></p> <ul style="list-style-type: none"> <li>SL-RCF90 Grub screws (supplied)</li> <li>Socket screws (supplied)</li> <li>2.5mm hex key</li> <li>3mm hex key</li> </ul> 
--	---

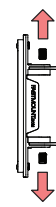
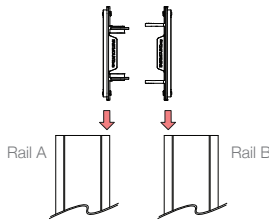
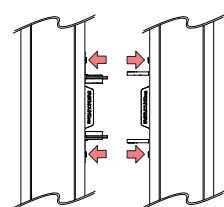
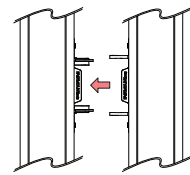
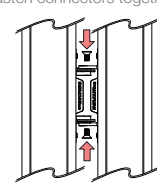
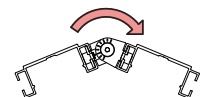
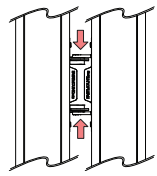
<p>Remove grub screws from teeth of SL-RCF90</p> 	<p>Slide SL-RCF90 into groove of SL-RLE Rail A, and slide SL-RCAB180 into groove of SL-RLE Rail B</p> 	<p>Tighten grub screws on both connectors using 2.5mm hex key</p> 
<p>Fit SL-RCAB180 into SL-RCF90</p> 	<p>Insert socket screws to fasten connectors together</p> 	<p>Adjust rails to desired corner angle</p> 
<p>Tighten socket screws using 3mm hex key</p> 		

# STRATLOCK RAIL SYSTEM

## SL-RCF90 How to build a wall

SL-RCF90



### USE WITH:

- SL-RLE
- Grub screws (supplied)
- Packers if required
- Appropriate substrate fastener
- 2.5mm hex key

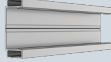

Slide SL-RCF90 into groove of vertical SL-RLE and tighten grub screws with 2.5mm hex key to secure.

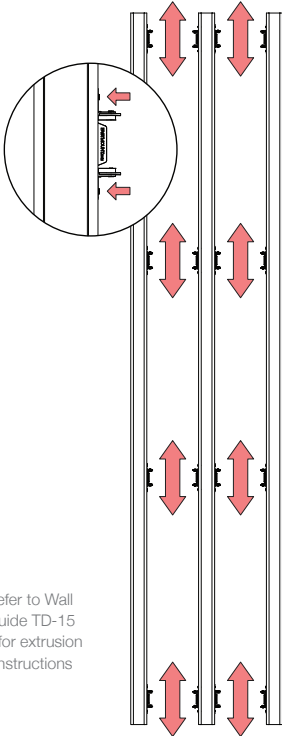

NOTE: Refer to Wall Layout Guide TD-15 & TD-16 for extrusion spacing instructions

Insert profile end of horizontal SL-RLE into SL-RCF90, tighten grub screws with 2.5mm hex key to secure.

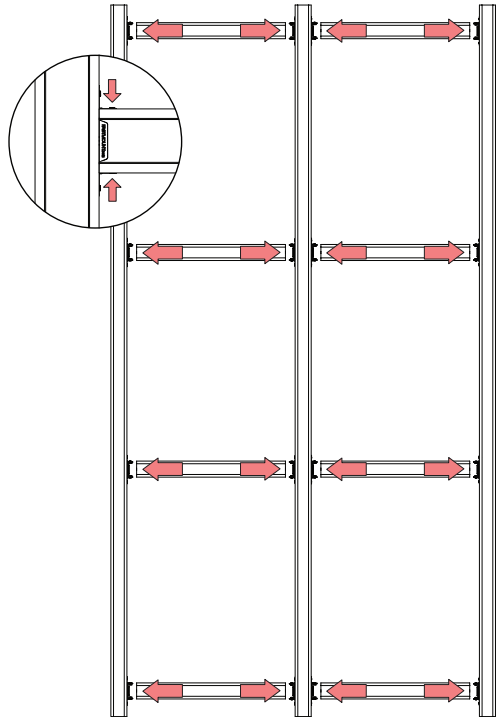

# SL-R

## INSTALLATION GUIDE

### SL-RCA180 How to connect a ceiling to wall grid

#### SL-RCAB180



#### USE WITH:

- SL-RCF90 Grub screws (supplied)
- Socket screws (supplied)
- Appropriate ceiling hangers
- 2.5mm hex key
- 3mm hex key



Position appropriate amount of SL-RCF90 connectors along groove of SL-RLE. Tighten grub screws with 2.5mm hex key to secure.

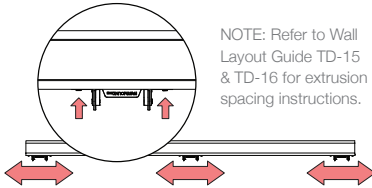

Insert SL-RCA180 into profile end of vertical SL-RLE. Tighten grub screws with 2.5mm hex key to secure.

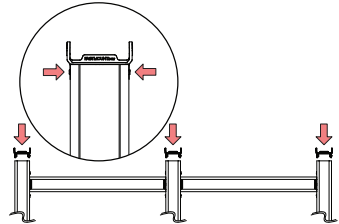

Insert SL-RCF90 into SL-RCA180, insert socket screws and adjust to desired angle.

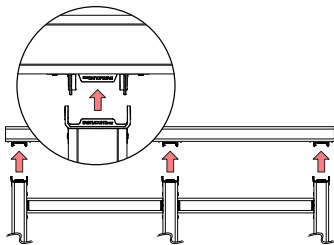

Adjust horizontal profile to desired position. Tighten socket screws with 3mm hex key to secure position.

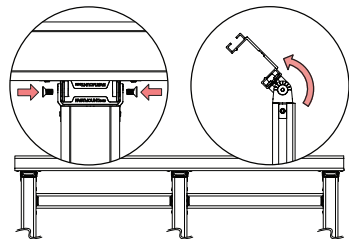

# STRATLOCK RAIL SYSTEM

## SL-RCAB180 How to create a wall corner

### SL-RCAB180



### USE WITH:

- SL-RCF90
- Grub screws (supplied)
- Socket screws (supplied)
- Packers/spacers
- Appropriate substrate hardware
- 2.5mm hex key
- 3mm hex key



Position appropriate number of SL-RCF90 into groove of extrusion A and SL-RCAB180 into groove of extrusion B.

Tighten grub screws with 2.5mm hex key once in position.

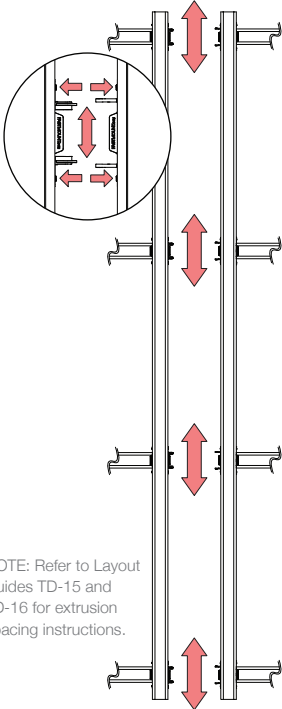

NOTE: Refer to Layout Guides TD-15 and TD-16 for extrusion spacing instructions.

Connect SL-RCF90 and SL-RCAB180

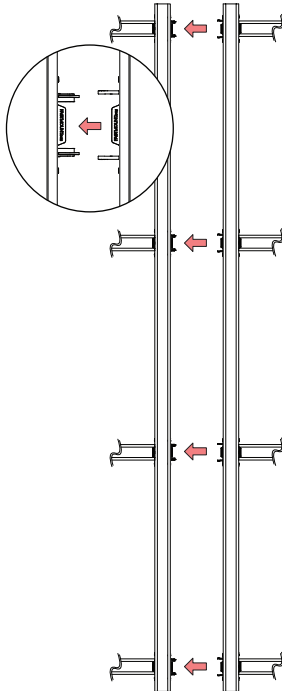

Fit socket screws and adjust to desired corner angle before tightening socket screws with a 3mm hex key.

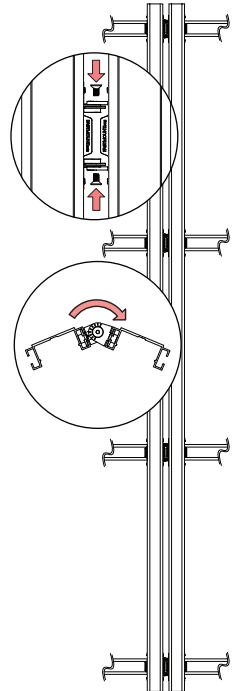

# SL-R

## INSTALLATION GUIDE

### FINISHING INSTALLATION WITH DOUBLE INTERNAL CORNERS

In cases where the wall grid cannot be pre-assembled, the following steps should be followed.

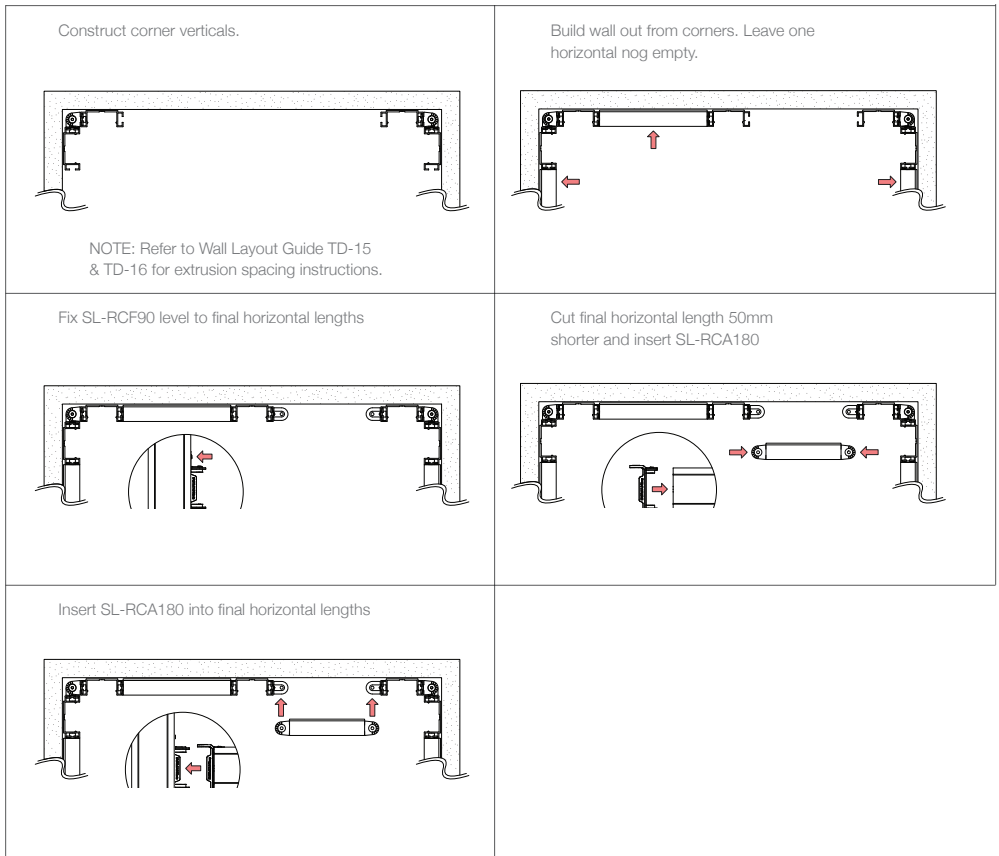
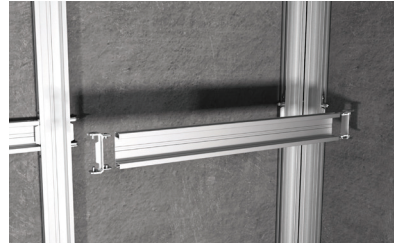



# STRATLOCK SL RANGE

## SL-FA Stratlock® Female Side Mount Clip

## SL-FA-FR Stratlock® Female Side Mount Clip - Fire Rated



### SPECIFICATIONS:

### STRATLOCK SL RANGE

The SL-FA provides rapid installation of heavy panels into side-channel aluminium extrusion framework. Designed specifically for contract interior fit out applications, the SL-FA / SL-FA-FR is also suitable for superyacht deckhead panels. Female installs rapidly with a twist-lock function into the side channel, and can be screwed or riveted into its final position. Used with the SL-M10/SL-M18 /SL-M18-FR, the new solid internal load chassis creates 4mm supported movement of the panel in any direction at the first engagement before locking into place with a 10/18kg pull out load. Patent Pending.

Designed for the new Stratlock Rail System by Fastmount, or fits into groove dimensions: mouth: 7.5mm - 8.5mm, depth: min 7mm, wall thickness: 0.75mm - 1.2mm. The distance between the panel and substrate when installed is 12.5mm at the first click, and 6mm when pressed into final position.

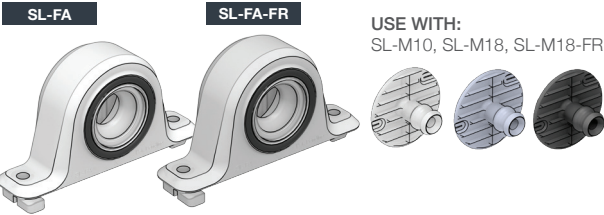

**MATERIAL:**  
White acetyl, rubber o-ring  
FR Nylon, rubber o-ring

**MORE INFO:**  
Installation Guide SL-FA  
Clip Layout Guide TD-15, 17

### BENEFITS

- Strongest mounting available
- T-lock function for rapid installation into channel with screw or pop rivet
- Supported movement of the panel 4mm in any direction before locking into final position.
- No special tools required for installation
- Acoustic isolation between panel and frame
- Designed for aluminium extrusion
- Option of 10kg or 18kg pull out load with SL-M10 or SL-M18
- 6mm standoff between frame and panel
- Adjustability along channel for easy spacing - no drilling required
- SL-FA-FR available in V-0 rated FR Nylon

### APPLICATIONS

- Commercial interior fit out
- Architectural and marine applications
- Mounting heavier ceiling and wall panels
- Hotels, hospitals, retail
- Residential fit out
- Superyacht deckhead panels
- Fire-rated interiors

**INSTALLATION:** Partially exploded through section showing typical installation method

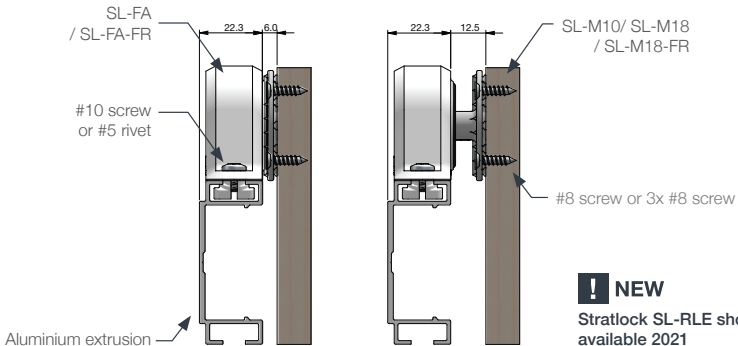

**NEW**  
Stratlock SL-RLE shown,  
available 2021

**SL-FB** Stratlock® Female Front Mount**SL-FB-FR** Stratlock® Female Front Mount - Fire Rated**SPECIFICATIONS:**

The SL-FB provides rapid installation of heavy panels into 18mm standard galvanized steel rail framework. Designed specifically for contract interior fit out applications. Female installs rapidly with a push fit function into the steel channel, and does not require fastenings. Used with the SL-M10/SL-M18 / SL-M18-FR, the new solid internal load chassis creates 4mm supported movement of the panel in any direction at the first engagement before locking into place with an 10/18kg pull out load. Patent Pending.

Designed for the new Stratlock Rail System by Fastmount, or fits into channel dimensions: mouth: 35.0mm - 35.75mm, depth: min 15.75mm - 16.5mm, wall thickness: N/A. The distance between the panel and substrate when installed is 12.5mm at the first click, and 6mm when pressed into final position.

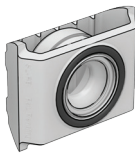
**SL-FB****SL-FB-FR****USE WITH:**

SL-M10, SL-M18, SL-M18-FR

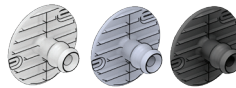
**MATERIAL:**

White acetyl, rubber o-ring  
FR PBT, rubber o-ring

**MORE INFO:**

Installation Guide SL-FB  
Clip Layout Guide TD-16, 18  
Panel Offset Guide

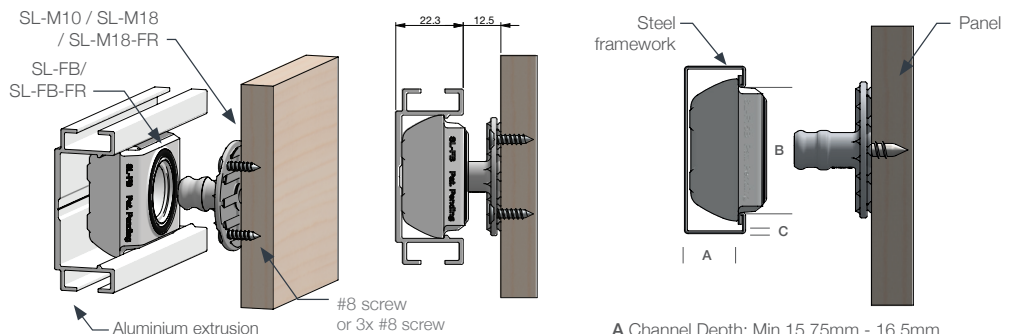
**INSTALLATION:** Partially exploded through section showing typical installation method

**!** NEW Stratlock SL-RLE shown, available 2021

**BENEFITS**

- Strongest mounting available
- Supported movement of the panel 4mm in any direction before locking into final position.
- Push fit into rail face
- No special tools required
- Acoustic isolation between panel and frame
- Fits into front channel steel extrusion
- Option of 10kg or 18kg pull out load with SL-M10 or SL-M18
- Adjustability along channel for easy spacing - no drilling required
- SL-FB-FR available in V-0 rated FR PBT

**APPLICATIONS**

- Commercial interior fit out
- Mounting heavier ceiling and wall panels
- Architectural applications
- Hotels, hospitals, retail, residential
- Fire-rated wall panels

- A** Channel Depth: Min 15.75mm - 16.5mm  
**B** Channel Mouth: 35.0mm - 35.75mm  
**C** (Channel Wall Thickness: Wall thickness does not effect clip)

# STRATLOCK SL RANGE

## PRODUCT SHEET

### SL-M10 Stratlock® Male 10kg

#### SPECIFICATIONS:

The male SL-M10 attaches to the panel, and mounts into either SL-FA , SL-SFA, SL-FB or SL-FC for rapid mounting of heavy panels to aluminium or steel extrusion framework, or solid substrates. The SL-M10 has a lower pull out load of 10kg for more frequently removed panels still requiring strength and high shear loading. Featuring a unique two-stage engagement head, the SL-M10 engages into the new solid internal load chassis to give 4mm supported movement in any direction before locking into place. Option to fix into panel using 1 x #8 screw, 3 x #8 screws or adhesive fix with Fastmount SuperGroove® Adhesive. No special tools required for installation. Patent Pending. Refer to Panel Offset Guide for gap between substrate and panel, pull out and shear loads.

**SL-M10** 10kg



**NEW !**

**MATERIAL:**  
White nylon

#### USE WITH:

SL-FA  
SL-SFA  
SL-FB  
SL-FC



#### MORE INFO:

Installation Guide SL-FA,  
SL-SFA, SL-FB, SL-FC  
Clip Layout Guide TD-15  
Panel Offset Guide

### STRATLOCK SL RANGE

#### BENEFITS

- 10kg pull out load
- Supported movement of the panel 4mm in any direction before locking into final position.
- Option to screw fix with 1 x #8, or 3 x #8 screws
- Option to adhesive fix with Fastmount SuperGroove® Adhesive
- No special tools required for install
- Acoustic isolation between panel and frame
- Fits into SL-FA, SL-SFA, SL-FB or SL-FC

#### APPLICATIONS

- Commercial interior fit out
- Mounting ceiling and wall panels
- Hotels, hospitals, retail, residential
- Superyacht deckheads

**INSTALLATION:** Partially exploded through section showing typical installation method

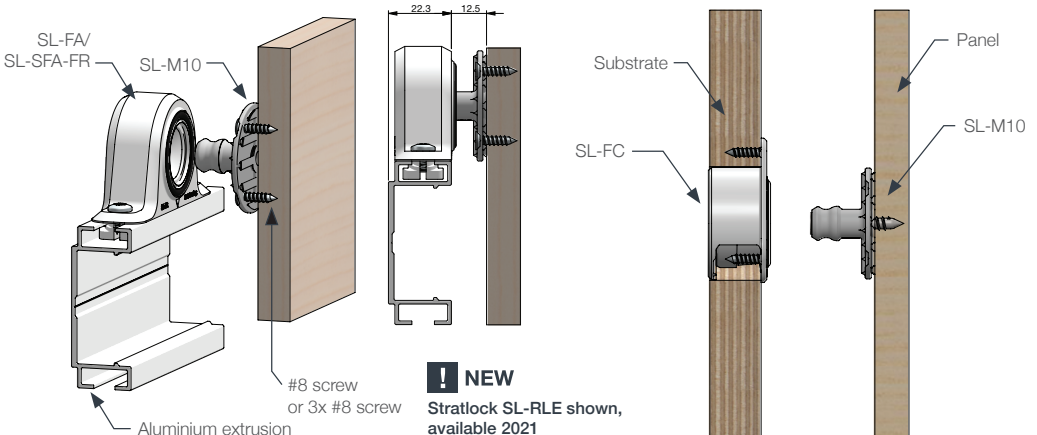

## SL-M18 Stratlock® Male 18kg

### SL-M18-FR Stratlock® Male 18kg - Fire Rated



#### SPECIFICATIONS:

The SL-M18 attaches to the panel, and mounts into either SL-FA, SL-SFA, SL-FB or SL-FC for rapid mounting of heavy panels to aluminium or steel extrusion framework. The SL-M18-FR/ SL-M18-FR can be combined with fire-rated female clips from the Stratlock Range where fire-resistance is required. Featuring a two-stage engagement head, the SL-M18 engages into the new solid internal load chassis to give 4mm supported movement in any direction before locking into place. Option to fix into panel with 1 or 3 #8 screws or Fastmount SuperGroove Adhesive. Combined with any female clip from the Stratlock Range, the SL-M10/SL-M18 / SL-M18-FR has an 10/18kg pull out load and high shear strength. Patent Pending. Refer to Panel Offset Guide for gap between substrate and panel, pull out and shear loads.

**SL-M18** 18kg

**SL-M18-FR** 18kg

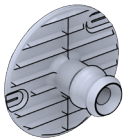

**NEW !**

**NEW !**

#### MATERIAL:

Off white glass-filled nylon  
Black Shineite

#### USE WITH:

SL-FA / SL-FA-FR  
SL-SFA / SL-SFA-FR  
SL-FB / SL-FB-FR  
SL-FC / SL-FC-FR

#### MORE INFO:

Installation Guide SL-FA,  
SL-SFA, SL-FB, SL-FC  
Clip Layout Guide TD-15  
Panel Offset Guide



#### STRATLOCK SL RANGE

#### BENEFITS

- Strongest mounting available
- Supported movement of the panel 4mm in any direction before locking into final position.
- Screw fix with 1 or 3 #8 screws, or Fastmount SuperGroove Adhesive or SuperGroove Adhesive fix
- No special tools required
- Acoustic isolation between panel and frame
- Fits into SL-FA / SL-FA-FR, SL-SFA / SL-SFA-FR, SL-FB / SL-FB-FR and SL-FC / SL-FC-FR
- 18kg pull out load & high shear strength

#### APPLICATIONS

- Commercial interior fit out
- Mounting heavier ceiling and wall panels
- Hotels, hospitals, retail, residential
- Superyacht deckheads
- Fire-rated interiors

**INSTALLATION:** Partially exploded through section showing typical installation method

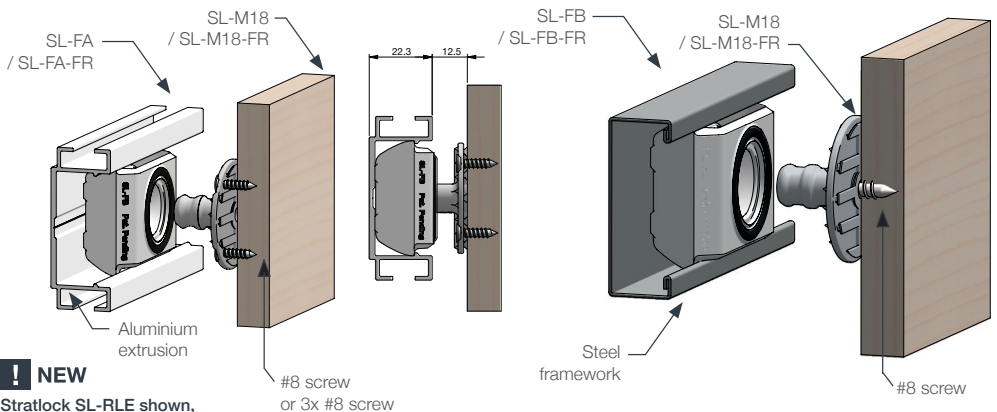



**! NEW**

Stratlock SL-RLE shown,  
available 2021

# STRATLOCK SL RANGE

**SL-FA** Stratlock® Range - Screw Fix

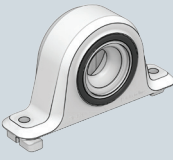
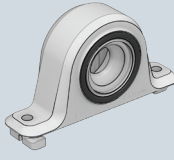
**SL-FA-FR** Stratlock® Range - Screw Fix - Fire Rated

SL-FA	SL-FA-FR	USE WITH:	INSTALL WITH:
			<p>#5 screws #8 screws #10 screws CP-01ST</p> 

## INSTALLATION STEPS Screw-fix method - follow same steps for fire-rated Stratlock clips

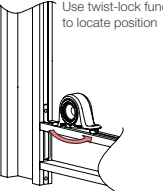
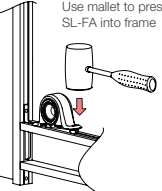
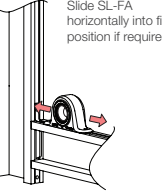
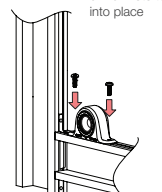
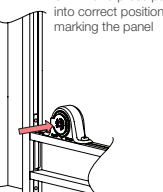
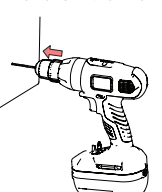
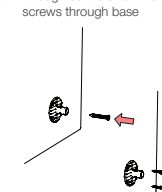
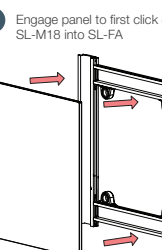
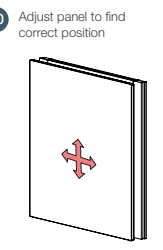
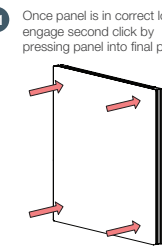
<p><b>1</b> Insert SL-FA into extrusion frame</p> 	<p><b>2</b> Use twist-lock function to locate position</p> 	<p><b>3</b> Use mallet to press SL-FA into frame</p> 	<p><b>4</b> Slide SL-FA horizontally into final position if required</p> 
<p><b>5</b> Use 2 x #10 screws or #5 rivets to fix into place</p> 	<p><b>6</b> Insert CP-01 ST into SL-FA and press panel into correct position, marking the panel</p> 	<p><b>7</b> Drill out mark created by CP-01 ST with 3mm drill bit</p> 	<p><b>8</b> Install SL-M18 with 1 x #8 screw through centre or 3 x #5 screws through base</p> 
<p><b>9</b> Engage panel to first click of SL-M18 into SL-FA</p> 	<p><b>10</b> Adjust panel to find correct position</p> 	<p><b>11</b> Once panel is in correct location, engage second click by pressing panel into final position.</p> 	<p><b>! NEW</b> Stratlock SL-RLE shown, available 2021</p>



### SL-FA Stratlock® Range - Adhesive Fix

<p><b>SL-FA</b></p> 	<p><b>USE WITH:</b></p> <p>SL-M10, SL-M18</p> 	<p><b>INSTALL WITH:</b></p> <p>Fastmount SuperGroove® Adhesive #10 screws</p>
---	---	---

#### INSTALLATION STEPS Adhesive fix method

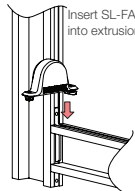
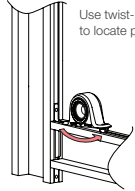
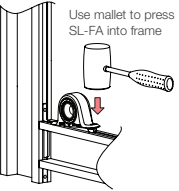
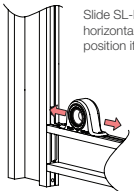
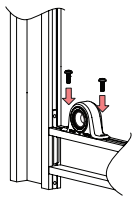
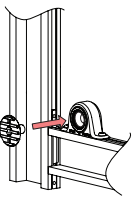
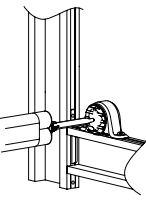
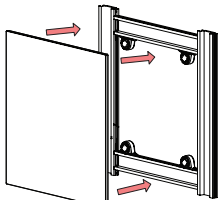
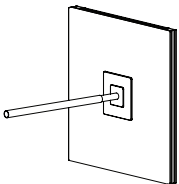
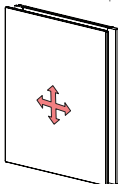
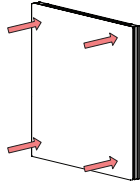
<p><b>1</b> Insert SL-FA into extrusion frame</p> 	<p><b>2</b> Use twist-lock function to locate position</p> 	<p><b>3</b> Use mallet to press SL-FA into frame</p> 	<p><b>4</b> Slide SL-FA horizontally into final position if required</p> 
<p><b>5</b> Use 2 x #10 screws or #5 rivets to fix into place</p> 	<p><b>6</b> Engage SL-M18 two clicks into SL-FA</p> 	<p><b>7</b> Apply Fastmount SuperGroove® Adhesive CG-5010 to SL-M18</p> 	<p><b>8</b> Press panel into place</p> 
<p><b>9</b> Use panel support while adhesive dries</p> 	<p><b>10</b> Once adhesive has dried, remove panel. Replace and engage one click to adjust panel to find correct position</p> 	<p><b>11</b> Once panel is in correct location, engage second click by pressing panel into final position.</p> 	<p><b>NEW</b> Stratlock SL-RLE shown, available 2021</p>

# STRATLOCK SL RANGE

## SL-FB Stratlock® Range - Adhesive Fix

SL-FB

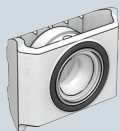

USE WITH:

SL-M10, SL-M18

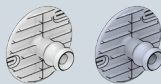

INSTALL WITH:

Fastmount SuperGroove®  
Adhesive

### INSTALLATION STEPS Adhesive fix method

1 Push fit SL-FB into frame

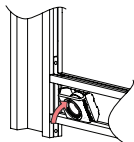

2 Locate SL-FB into correct position

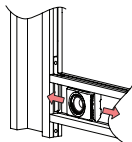

3 Engage SL-M18 two clicks into SL-FB

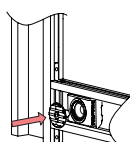

4 Apply Fastmount SuperGroove Adhesive CG-5010 to SL-M18

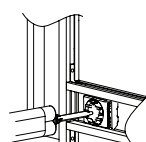

5 Press panel into place

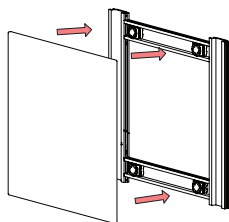

6 Use panel support while adhesive dries

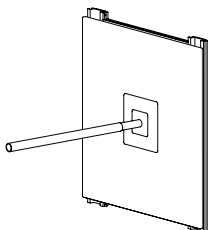

7 Once adhesive has dried, remove panel. Replace and engage only one click to adjust panel around the SL-M18's point

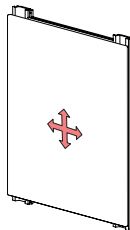

8 Once panel is in desired location, engage second click by pressing panel into its final position

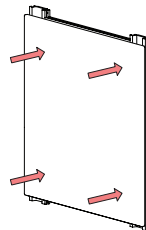

### NEW

Stratlock SL-RLE shown,  
available 2021

**STRATLOCK** RAIL SYSTEM  
BY FASTMOUNT

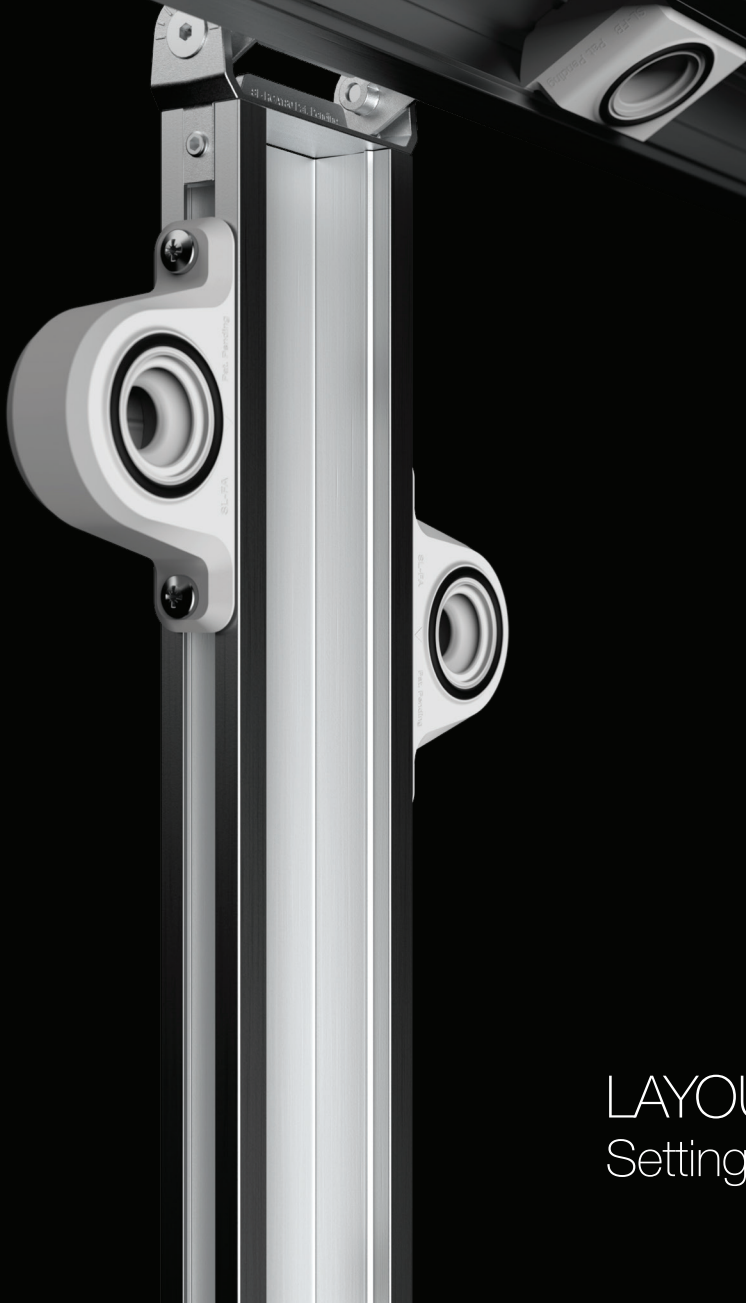

LAYOUT GUIDES  
Setting the standard

# LAYOUT GUIDE FOR LARGE WALL PANEL STRATLOCK RANGE - SL-FA & SL-SFA

TD-15

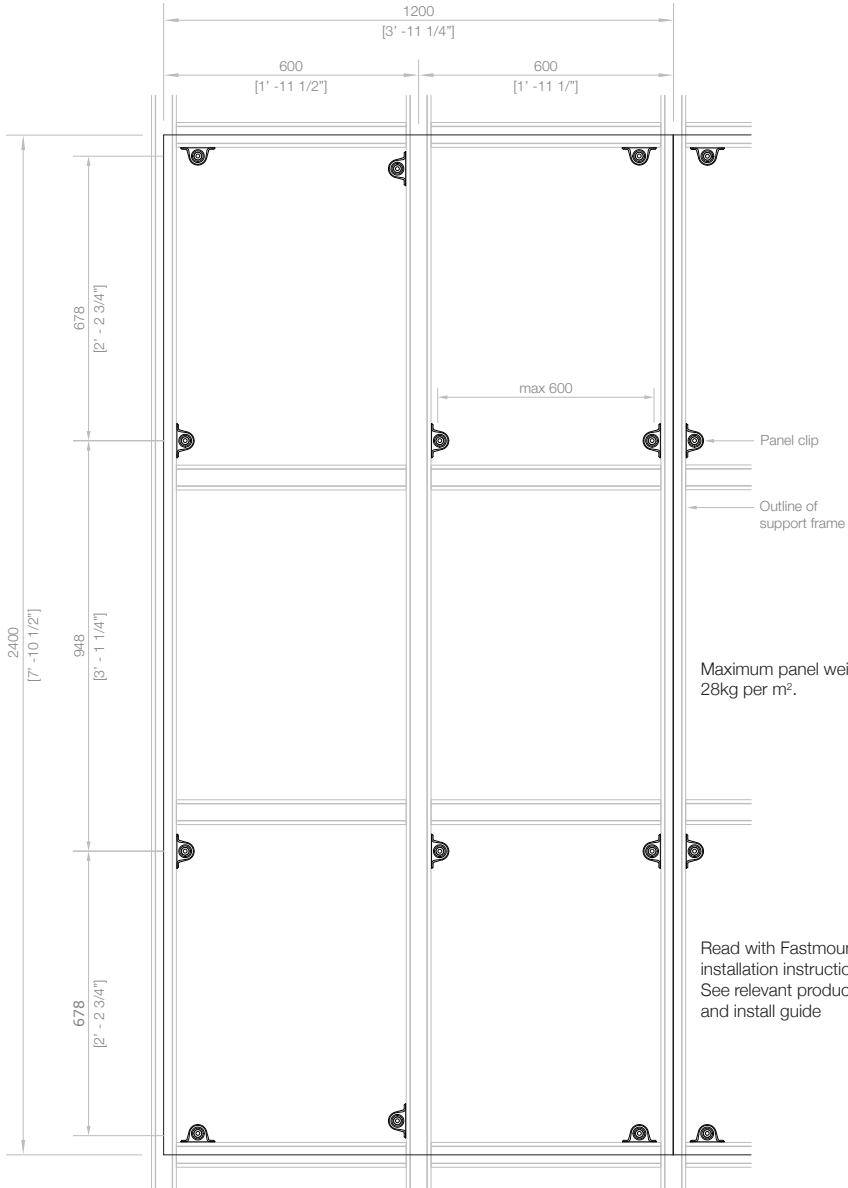

# LAYOUT GUIDE FOR LARGE WALL PANEL STRATLOCK RANGE - SL-FB

TD-16

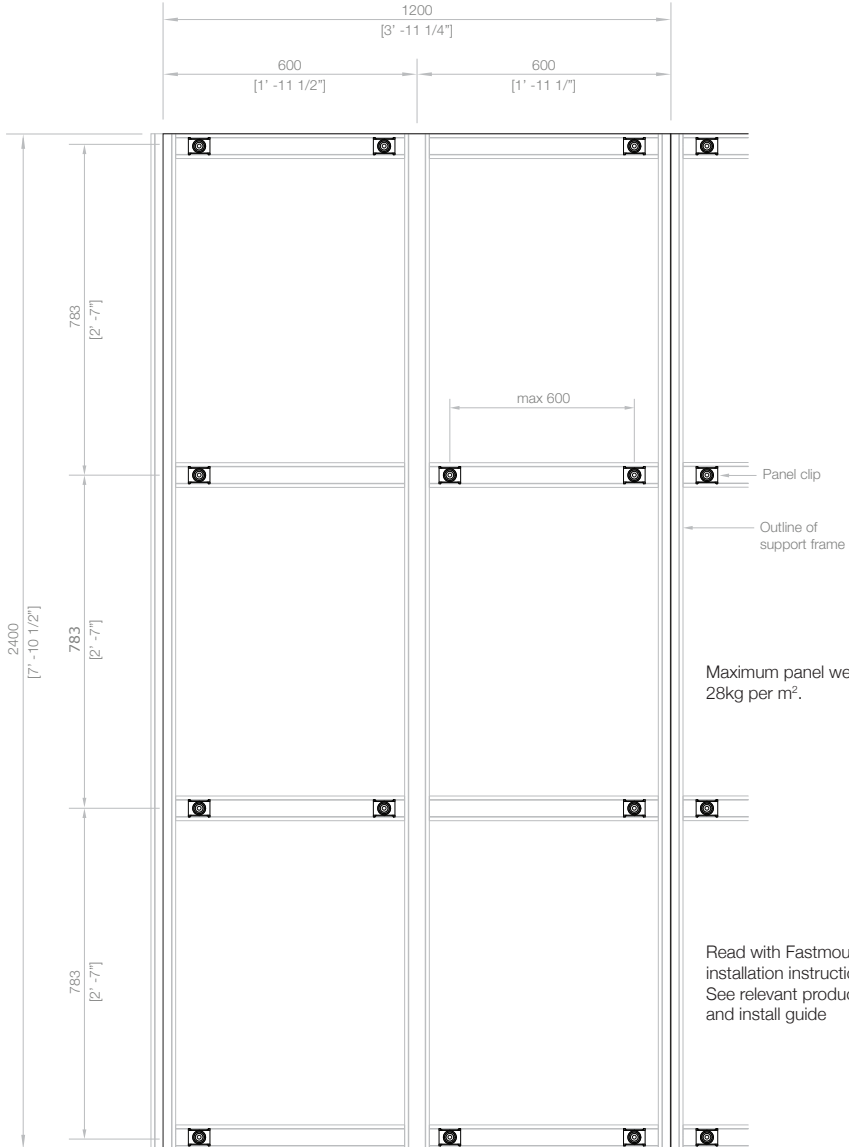

# LAYOUT GUIDE FOR CEILING PANEL STRATLOCK RANGE - SL-FA & SL-SFA

TD-17

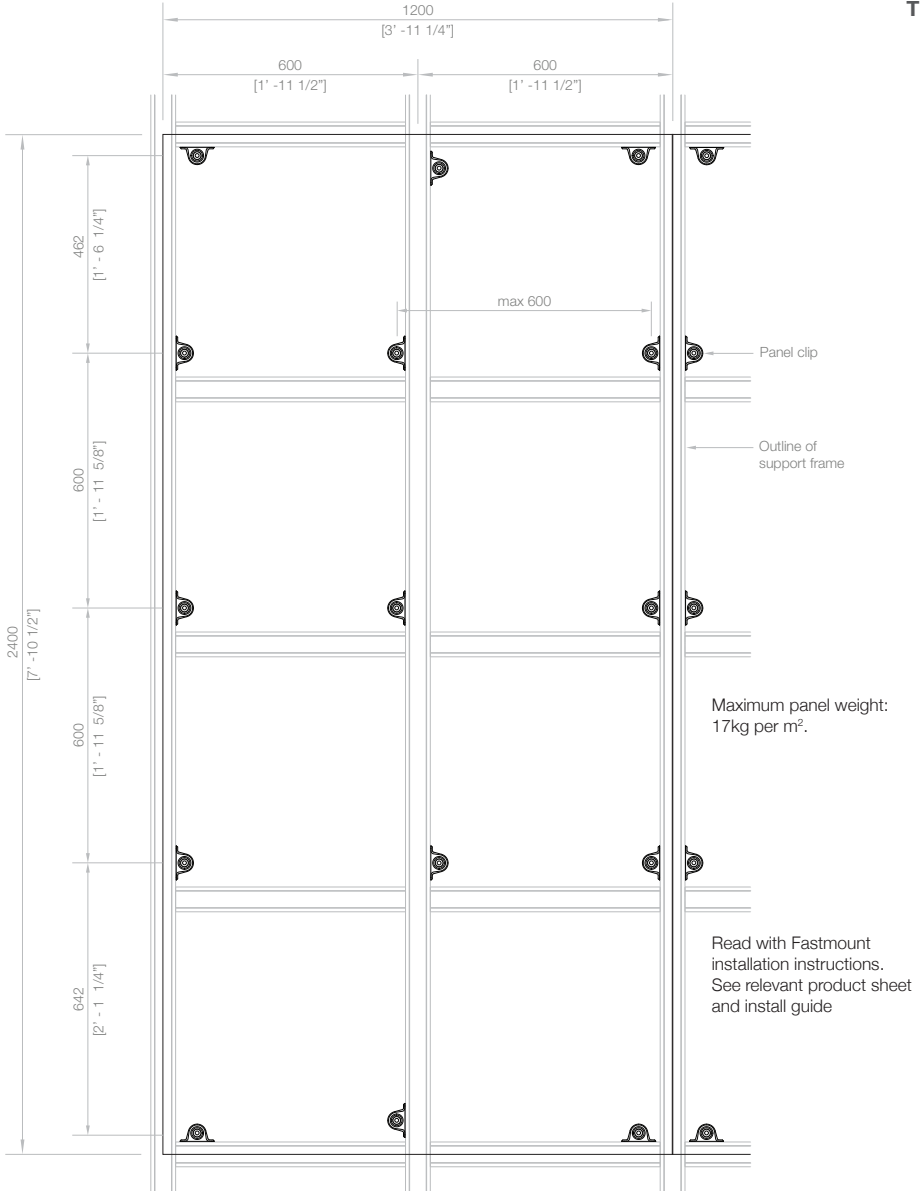



# LAYOUT GUIDE FOR CEILING PANEL STRATLOCK RANGE - SL-FB

TD-18

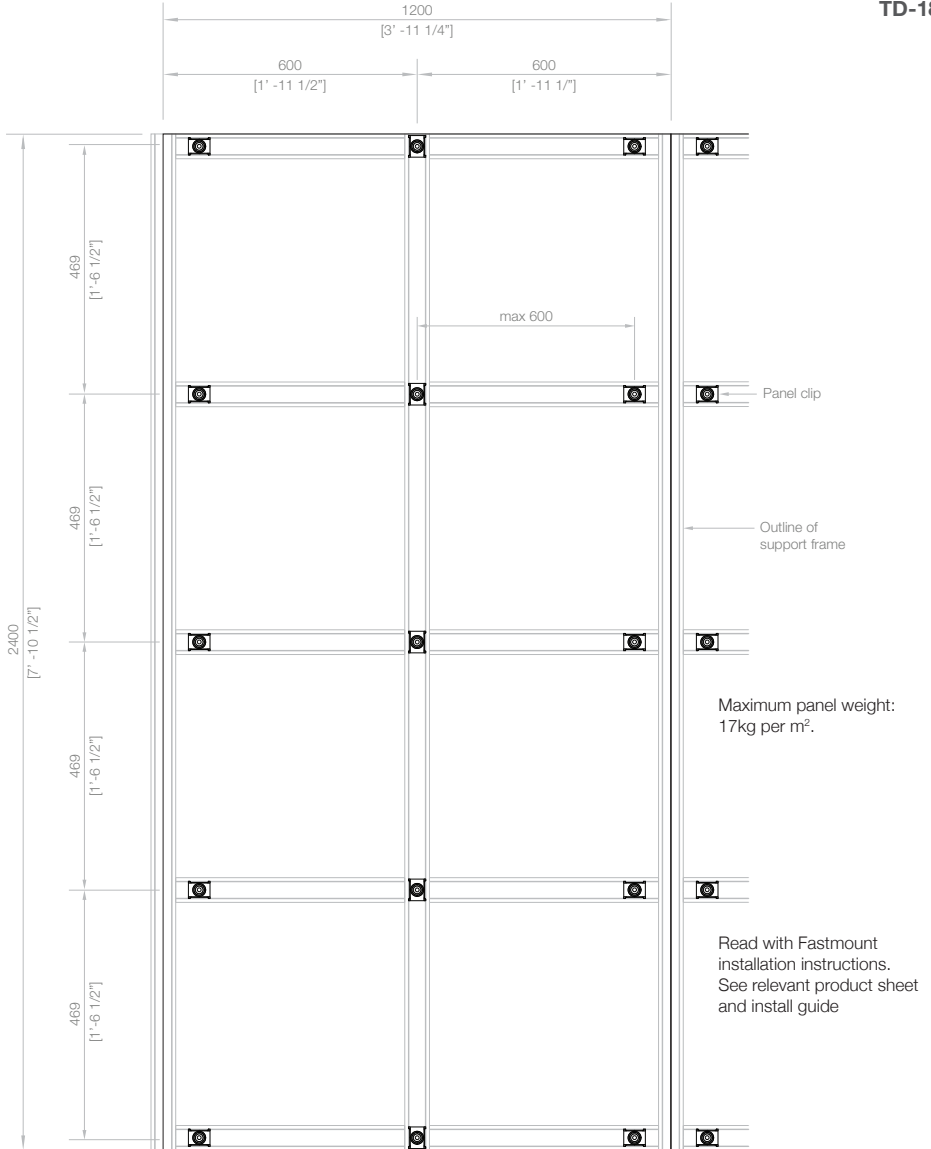

# PANEL OFFSET GUIDE - SL

	GAP	LOAD KG	SHEAR KGF	GAP	LOAD	SHEAR
<b>SL RANGE + STRATLOCK RAIL SYSTEM</b> (Front face of rail to back face of panel)	SL-FA			SL-SFA		
	SL-M18 (First click)	12.5mm	n/a	n/a	12.5mm	n/a
SL-M18 (Second click)	6mm	18	142	6mm	18	-
SL-M10 (First click)	12.5mm	n/a	n/a	12.5mm	10	n/a
SL-M10 (Second click)	6mm	10	117.2	6mm	10	130
<b>SL RANGE + STRATLOCK RAIL SYSTEM</b> (Back of rail to back face of panel)						
	SL-M18 (First click)	34.8mm	n/a	n/a	n/a	
SL-M18 (Second click)	28.3mm	18	142	n/a		
SL-M10 (First click)	34.8mm	n/a	n/a	n/a		
SL-M10 (Second click)	28.3mm	10	142	n/a		

**STRATLOCK** RAIL SYSTEM  
BY FASTMOUNT

GAP			LOAD			SHEAR		
SL-FB			SL-FC					
12.5mm	n/a	n/a	13.5mm	n/a	n/a			
6mm	18	89	7mm	18	181.4			
12.5mm	n/a	n/a	13.5mm	n/a	n/a			
6mm	10	95.6	7mm	10	181.4			

38.3	n/a	n/a	n/a
31.8	18	89	n/a
38.3	n/a	n/a	n/a
31.8	10	89	n/a

# TECHNICAL INFORMATION

## PULL OUT LOADS

The pull out loads will vary depending on the clip type and are specified on each product sheet. The Stratlock Range offers a 10kg or 18kg pull out option, which can be used according to how frequently the panel will be removed.

The shock load is less and can be as low as 2kg, depending on the type of shock load. Clips never load simultaneously on a panel, so if a panel has 10 clips it does not mean the force required to remove the panel (or the force the panel will take) is 10 x 5kg.

NB. For official SGS performance reports covering pullout loads, repetitive pull out loads and shear loads, please refer to [www.fastmount.com](http://www.fastmount.com)

## CLIP SPACING AND PANEL LOADS

Panels need to be supported evenly around the perimeter to eliminate sagging. The clip spacing requirements will vary depending on the application. Refer to the Fastmount Clip Layout Guides on previous pages or online: [www.fastmount.com/en/clip\\_system/clip\\_layout\\_guides](http://www.fastmount.com/en/clip_system/clip_layout_guides)

Although many of the Fastmount clip sets will hold more than your potential panel load, the reality of unknown conditions means panels and clips could be subjected to shock loads (g-forces) from huge seas or seismic shocks. From our experience it is best to follow our guidelines and also conduct tests of panel type and substrate on a project-by-project basis. If you require advice email [info@fastmount.com](mailto:info@fastmount.com)

## ADHESIVES FOR SURFACE MOUNT CLIPS

Our patented SuperGroove® design means the Fastmount surface mount clips use a mechanical engagement to secure the clip, so adhesive selection is mostly dependant on panel material.

A typical two-part epoxy will hold the clip at over three times the clipping load (30-40kg per clip).

We recommend the Fastmount SuperGroove Adhesive, a two-part epoxy designed specifically for use with the Fastmount range.

## PANEL TREATMENT NOTES (PLYWOOD, MDF, COMPOSITE FOAM PANELS)

When selecting the type of finish on your panels, ensure you follow the golden rule of 'balancing' the panel - however you treat the face side of the panel or sheet must be duplicated on the back face of the panel.

This is to prevent the panel from warping, due to the unbalanced tension that a single coating or veneer applied to one face of the panel exerts. For example, if the panel face is a paint finish, then the back face will also require a paint finish to balance the tension in the panels. In the case of veneered panels, when applying good veneer on the face side, apply any type of veneer on the back face for the best finish.

As a test to prove this, take a dry plywood or MDF panel approximately 500 x 200mm, coat one face only with water, leave the other face dry and put it in the sun. The panel will warp within hours, which is precisely the same effect as painting one side only, however it may take months for this to happen as moisture is absorbed unevenly from the atmosphere.

## QUALITY INSTALLATION

To ensure consistent and quality installation, Fastmount supplies tools where required.

Installation guides and videos are available for each range on [www.fastmount.com](http://www.fastmount.com)



# FREQUENTLY ASKED QUESTIONS

## **WHAT IS THE BENEFIT TO USING THE STRATLOCK RAIL SYSTEM**

### **OVER OTHER EXTRUSION TYPES?**

The Stratlock Rail System is the only system that the Stratlock clips are specifically designed for, and using the SL-FA or SL-FB enables superior versatility for interior fit outs. The Rail System is unique in that faceted or angled walls and ceilings can be constructed easily. This also allows for precise corner junctions, and wall to ceiling junctions giving a precise panel fit.

## **IS THE STRATLOCK RAIL SYSTEM SUITABLE FOR THE MARINE INDUSTRY?**

Yes. The SL-RLE is made from 6063 T5 grade aluminium (marine grade) making it ideal to use in place of traditional plywood or timber deckhead substrates, being an inert material providing precise grounds for interior panels.

## **WHAT LENGTHS ARE THE RAILS SOLD IN?**

The rails are sold in 3 metre lengths, and can be cut to size.

## **HOW MANY CLIPS DO I NEED TO USE PER M2 OF PANEL?**

A combination of 4 SL-FA / SL-FB clips can be used.

## **CAN I USE THE SL-FB ON VERTICAL RAILS?**

We recommend the use of the SL-FA on vertical rails, and SL-FB on horizontal rails.

## **CAN I USE THE SYSTEM TO MAKE FLOORS?**

While not specifically designed for floor grids, the rail system can be used for this application as long as the rails are supported securely with adjustable joist supports, to the base substrate every 500mm along the lengths.

## **HOW DO I MAKE CORNERS?**

A corner can be created using either the SL-RCF90 + SL-RCA180 for a wall to ceiling 'corner' or the SL-RCF90 + SL-RCAB180 for a wall-to-wall corner. See the corresponding installation guides or videos for a breakdown of installation.

## **WHAT GRADE IS THE ALUMINIUM EXTRUSION MADE OF?**

Aluminium grade 6063 T5

## **WHAT GRADE ARE THE CAST ALUMINIUM CONNECTORS?**

ADC12

## **WHAT IS THE BEST WAY TO TIGHTEN THE GRUB OR SOCKET SCREWS?**

Use a 2.5mm hex key for the grub screws and a 3mm hex key for the socket screws. Alternatively, use a right-angle chuck in a battery driver to speed up the process.

## **HOW TO LEVEL THE FRAMEWORK ON AN UNEVEN WALL?**

Use the correct screws for the substrate type and pack the vertical extrusions off the substrate until level then screw in place every 1 metre, before connecting the horizontal extrusions (nogs).



# MAINTENANCE GUIDE

## **MAINTENANCE OF PANELS MOUNTED WITH FASTMOUNT CLIP SYSTEMS**

Fastmount clips have been designed to be removed and refitted easily. The clips are hidden when in place and require no special maintenance. The Fastmount panel mounting system allows for easy access to maintain wiring, electronics and plumbing in the substrate, as well as access to storage behind the panels.

### **TO REMOVE PANELS**

Use cotton gloves when handling panels.

Covered panels should be removed using the CT-05 panel removal tool introduced at the corner edge of the panel and then pulling the panel gently away from the support frame, slowly disengaging each line of clips.

Painted or prefinished panels should be removed using two of the CT-17 glass suckers or the CT-05H heavy duty removal tool using the attached hook.

NOTE: if the panels are very long, wide or heavy always ensure that 2 people handle the panel for safety and to minimize extreme pressure on the clips.

### **TO REFIT PANELS**

Use cotton gloves when handling panels. Present the panel up to the original panel space and firmly push panels into place ensuring all clips are engaged. Use a firm pressure, do not hit the panel hard with your hand to engage clips – this can cause damage to the panels and the clips.



# FASTMOUNT AUTHORISED DISTRIBUTORS

## AFRICA

**Dynamic Supply Systems (DSS)**  
+27 (0)82 387 5324

## AUSTRALIA

**MarineWare**  
+61 (7) 5502 8966

**Titus Tekform Pty Ltd**  
+61 (02) 9826 0007

AUSTRIA & GERMANY  
**Robert Lindemann KG**  
+49 (0)40 211197 20

BAHRAIN, KUWAIT,  
SAUDI ARABIA & UAE  
**Exalto Emirates LLC**  
+971 (0)6 545 3366

## BELARUS

**Furniplast**  
+37 5296 650065

## BRAZIL

**I-Sea**  
+5511 9 9922.5505

## CANADA

**Western Marine**  
+1 604 253 3322  
**Sugatsune Canada Inc**  
+1-514-312-5267

## CHILE

**Rce latam**  
+56 9 3467 9401

## CHINA

**Sugatsune Shanghai**  
+86-21-3632-1858 extn 802

## CROATIA

**Yachthings**  
+385 52 63 56 15

## DENMARK

**HF Industri & Marine**  
+45 6220 1312

## ESTONIA

**Gamma Baltic OÜ**  
+372 6459757

## FINLAND

**MarineMan Oy**  
+358 10 4235220

## FRANCE

**Domarine**  
+33(6)72 808 185

## GREECE

**VIOTAP**  
+30 210 24 65 510

## HUNGARY

**Kerimpex Kft.**  
+36 1 3330010

## INDIA

**Sugatsune Kogyo India**  
+91-22-2831-4490 & 4491

## ITALY

**Promotech Italia Srl**  
+39 0584 55 026

## JAPAN

**Sugatsune Co Ltd**  
+81 (03) 3866-2267

## KOREA

**Young & Sun Int'l Inc.**  
+82 31 716 7994

## LATVIA

**Gamma Fittings SIA**  
+371 29207538

## LITHUANIA

**UAB Furnitanas**  
+37052323052

## NETHERLANDS

**Kroon B.V.**  
+31 (0) 598-858585

## NEW ZEALAND

**QCD Ltd**  
+64 09 815 7500

## POLAND

**Nowacore**  
+48 504 071 930

## RUSSIA

**New Furniture Technologies Ltd**  
+7 (812) 703 01 13

## SINGAPORE

**Beltiston Ventures Pte Ltd**  
+65 6367 3148

## SPAIN

**Riviera Trade**  
+34 606 959 967

## SWEDEN

**HF Marin Sweden AB**  
+46 550 77 11 11

## TAIWAN

**Asia Connect**  
+886 07 2229224

## THAILAND

**Brand House Asia**  
+66 (0)76527 772

## TURKEY

**Neva Marine**  
+90 (216) 447 0600

## UK

**Sugatsune Kogyo(UK) Ltd**  
+44 (0) 1189 272 955

## UKRAINE

**Mebelnye Technology**  
+380444923000

## USA

**Spradling Int'l Marine**  
+1 800 967 7753  
**Sugatsune America**  
+1 800-562-5267

## TECHNICAL SUPPORT

AUSTRALASIA  
**Fastmount Ltd**  
+64 21725418

EUROPEAN UNION  
**Domarine**  
+33 (0) 672 808185

## UK

**Sugatsune Kogyo (UK) Ltd**  
+44 (0) 1189 272 955

## USA & CANADA

**Sugatsune America, Inc**  
+1 (310) 329-6373

# FASTMOUNT RANGE OVERVIEW

## STANDARD PC RANGE

Please note, some products are not to scale

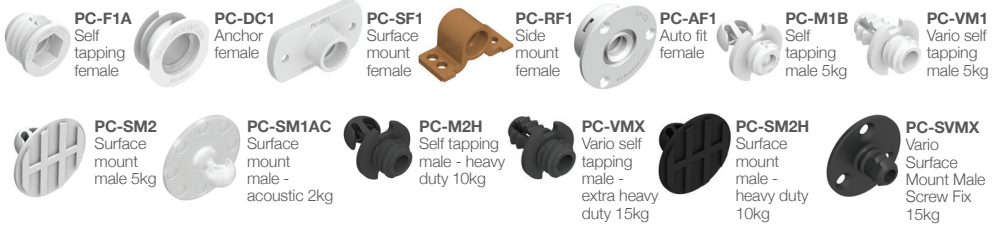

## LOW PROFILE LP RANGE



## VERY LOW PROFILE VL RANGE



## STRATLOCK SL RANGE - fire-rated versions available



## METAL MC RANGE

## TEXTILE TC RANGE



## PANELSAFE PS RANGE RANGE













Supplying to thousands of companies in over 50 countries, the Fastmount® Panel Mounting System offers exceptional panel mounting solutions for the marine, architectural, aviation and recreational vehicle industries. Its global network of distributors ensures easy accessibility to the Fastmount system worldwide.

Visit [fastmount.com](http://fastmount.com) to find your nearest distributor or request a trial kit online.

 **STRATLOCK** RAIL SYSTEM  
BY FASTMOUNT



PROUDLY DESIGNED & MANUFACTURED IN NEW ZEALAND

Copyright © 2021 Fastmount

