

HALO

UNIFORM LIGHTING FRAMES



BACKLIGHT
Designed and Made in Italy

One fusion of Technique and Design for one perfect lighting.

Designed and produced in Italy since 1998 and exported to more than 100 countries worldwide.

Index

04 | **What is HALO**

05 | **Size**

06 | **Technical specs**

07 | **Sections**

08-09 | **Ceiling & Wall recessed** by magnets and iron plate

10-11 | **Installation manual** | Ceiling & Wall recessed

12-13 | **Ceiling & Wall surface** by magnets and iron plate

14-15 | **Installation manual** | Ceiling & Wall surface

HALO

The architecture of light.

The Backlight HALO line is a versatile and elegant lighting solution designed to create a perimeter lighting effect. Its main uses include lighting around mirrors, elevator lighting, and more generally, can be installed on both walls and ceilings, as well as used as suspensions.

These lamps are produced in a single, custom-made piece, with the possibility of being made in irregular shapes.

The lamps in the HALO line stand out from other similar products for their construction that avoids the visibility of common joints normally present at the corners.

Thanks to this, HALO guarantees perfect light uniformity and an impeccable result. It is possible to choose the color temperature of the light among various available options, customizing the light according to design needs and creating a perfect atmosphere for every occasion.

Sizes

WIDTH OF LIGHT

15.24 mm (0.6")

25.4 mm (1")

30.48 mm (1.2")

35.56 mm (1.4")

40.64 mm (1.6")

50.8 mm (2")

76.2 mm (3")

101.6 mm (4")

152.4 mm (6")

203.2 mm (8")

SHORT SIDE

MIN - 203.2 mm (8 in)

MAX - 2006.6 mm (79 in)

LONG SIDE

















MIN - 203.2 mm (8 in)

MAX - 3048 mm (120 in)

Available in custom width under request



Technical Specs

COLOR TEMPERATURE													
	2000 K	2700 K	3000 K	3500 K	4100 K	5000k	Tun. White 2000-6500K	Tun. White 2700-6500K	Custom range Tun. White*	RGB	RGBW*	RGBWW*	DIM to WARM*
	*Under request for a minimum order quantity to be define.												
CRI	> 95												
INPUT VOLTAGE	24VDC												
DRIVER	AC DC 24V DC OUTPUT (class 2 Power Unit)												
DIMMABILITY	by all existing systems (ELV/MLV, 0-10V, DALI, LUTRON, DMX ...)												
POWER CONSUMPTION	14 W per linear mt (4,5 W per linear ft) of perimeter												
LUMEN DELIVERED	890 lm per linear mt (280 lm per linear ft) of perimeter												
IP GRADE	IP40 for Dry Location (IP54 for Damp Location under request)												
DIMENSIONS	Short side MM 203.2 to 2006.6 mm INCHES 8.0 to 79.0 in												
	Long side MM 1101.6 to 3048.0 mm INCHES 4.0 to 120.0 in												
	Width of light 15.24 mm (0.6") 30.48 mm (1.2") 40.64 mm (1.6") 76.2 mm (3") 152.4 mm (6") 25.4 mm (1") 35.56 mm (1.4") 50.8 mm (2") 101.6 mm (4") 203.2 mm (8")												
LIFE TIME	70.000 hrs												
WARRANTY	3 Years (36 month)												
CERTIFICATIONS	   												

Sections

RECESSED MOUNTING by magnets and iron plate

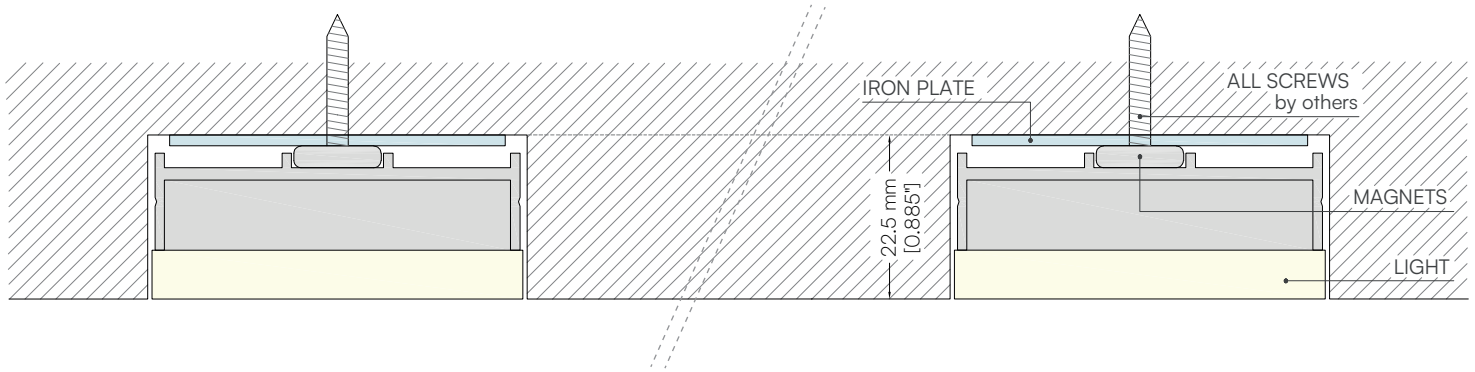

SURFACE MOUNTING by magnets and iron plate

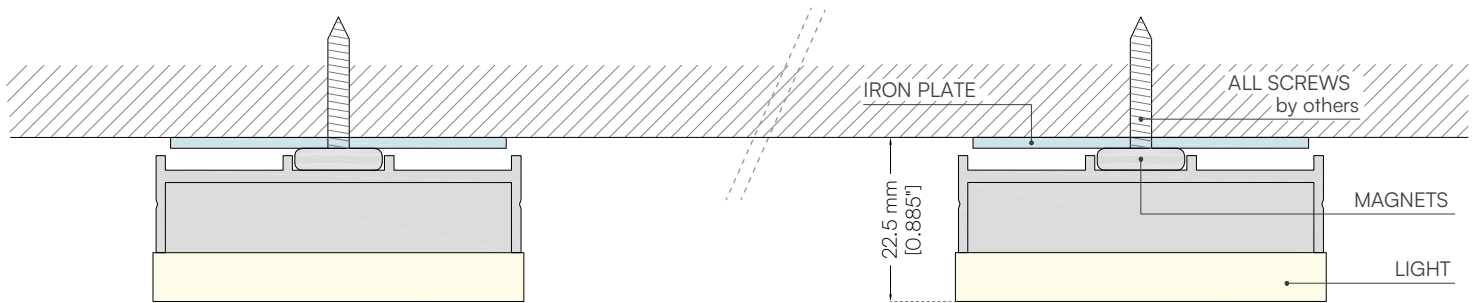



CEILING RECESSED MOUNTING

By magnets and iron plate

WALL RECESSED MOUNTING

By magnets and iron plate



INSTALLATION MANUAL | HALO WALL & CEILING RECESSED MOUNTING by magnets and iron plate

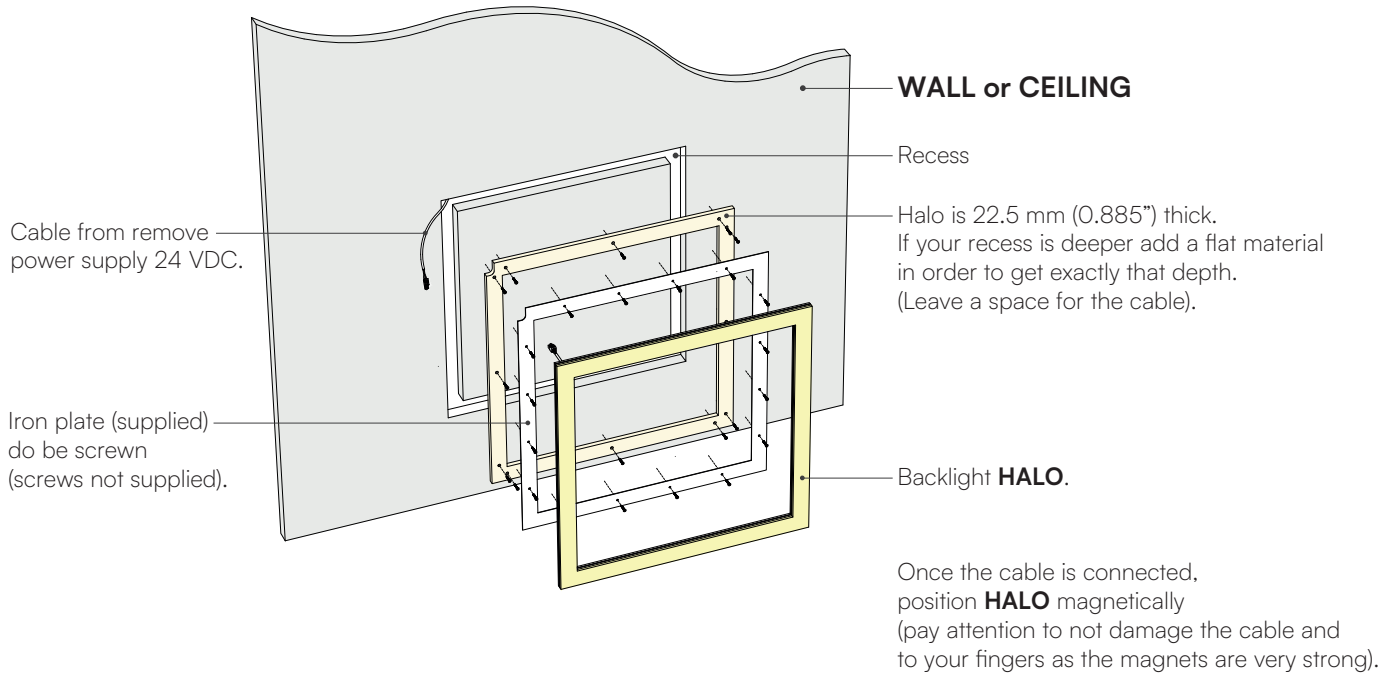

Note: The cup of screws must be less deep then 3mm.

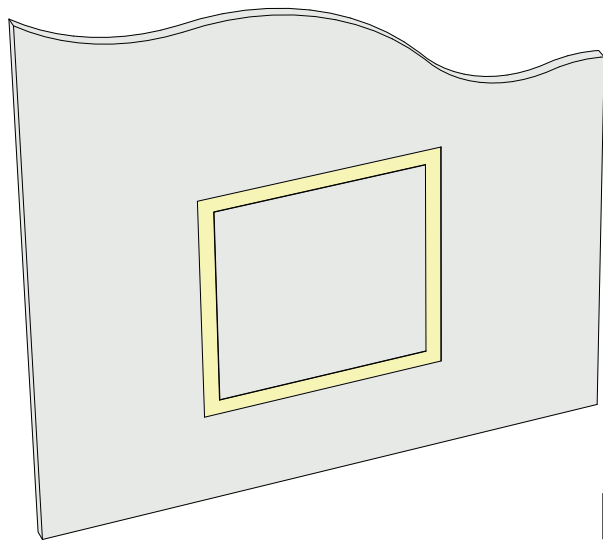

Enjoy.



CEILING SURFACE MOUNTING

By magnets and iron plate

WALL SURFACE MOUNTING

By magnets and iron plate



INSTALLATION MANUAL | HALO WALL & CEILING SURFACE MOUNTING by magnets and iron plate

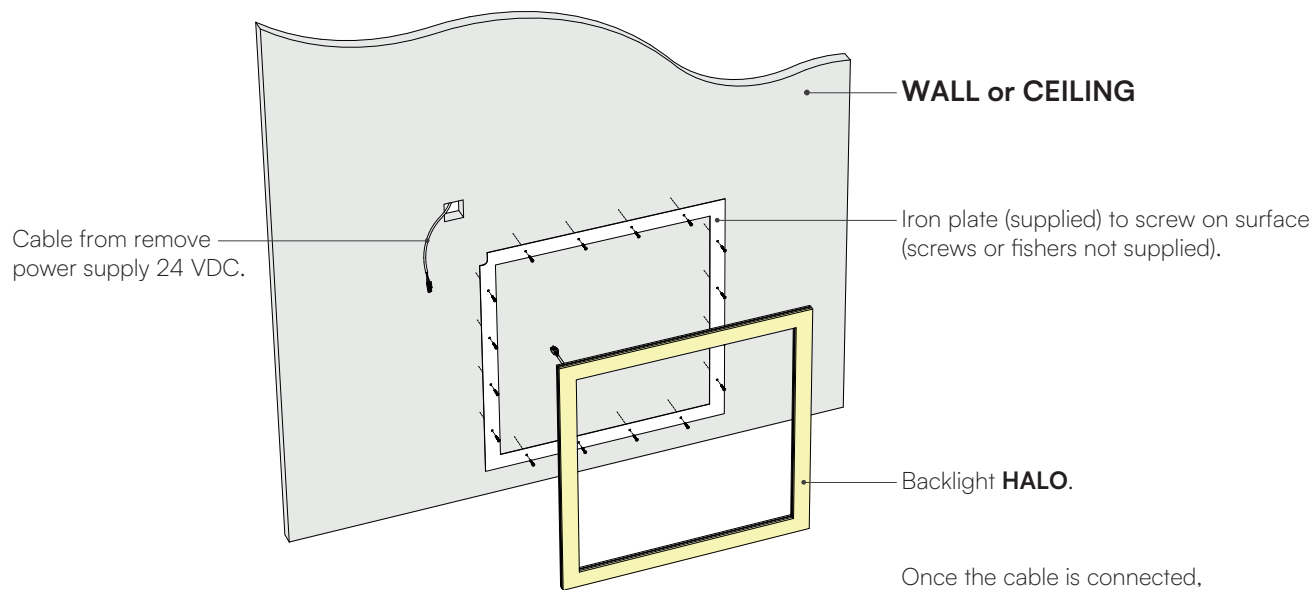

Once the cable is connected, position **HALO** magnetically (pay attention to not damage the cable and to your fingers as the magnets are very strong).

Note: The cup of screws must be less deep than 3mm.

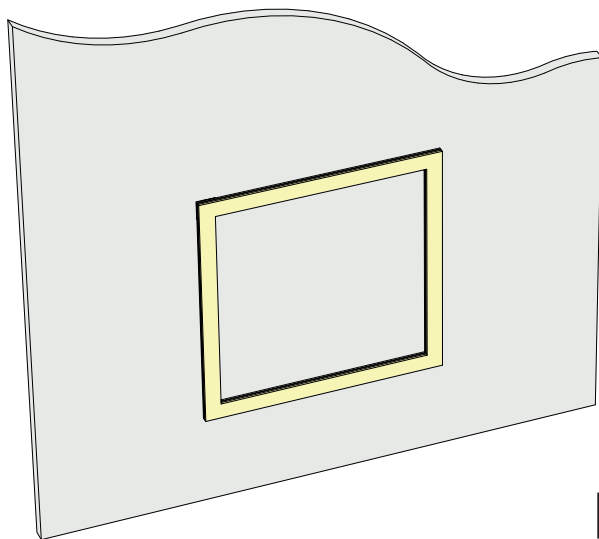

Enjoy.

















*Discover all our most famous products
that have made and still make lighting history.*

MAGIC CLOUD Custom Uniform Lighting Panels

FLUSH Custom Uniform Lighting Bars

HALO Custom uniform Lighting Frames in a single piece

HIDE Line of Uniform Lighting Circles

PILL Plasterboard built-in Square and Round Lights

WETTY WET / IP67 Line

CHIARO Lighting Integration for ARMSTRONG CEILINGS

STAMP Creative light on plasterboard



www.backlightsrl.com

BACKLIGHT

Via Alessandro Volta, 5
20876 Ornago (MB)
Italy

+39 039 6010396
www.backlightsrl.com
info@backlightsrl.com

f @ in ▶ | BACKLIGHTSRL